

ROBERTS

Enjoy Listening

Chronoplus 2

FM / MW dual alarm clock radio with instant time set



Please read this manual before use

Contents

<i>Contents</i>	1	<i>Specifications</i>	18
<i>Controls</i>	2-5	<i>Circuit features</i>	18
<i>Switching on</i>	6	<i>Mains supply</i>	19
<i>Setting the time manually</i>	6	<i>General</i>	20
<i>Setting the year manually</i>	7	<i>Troubleshooting</i>	21
<i>Setting the date manually</i>	7	<i>Guarantee</i>	22
<i>Setting alarm times</i>	8		
<i>Setting alarm day</i>	9		
<i>Weekday alarm</i>	9		
<i>Weekend alarm</i>	10		
<i>Everyday alarm</i>	10		
<i>Checking alarm times</i>	11		
<i>Snooze control</i>	11		
<i>Sleep timer</i>	12		
<i>Listening to the radio</i>	13		
<i>Dimmer</i>	13		
<i>Back-up battery</i>	14		
<i>Changing the back-up battery</i>	15		
<i>Time zones</i>	16		
<i>Headphones</i>	17		

Controls

(Top)

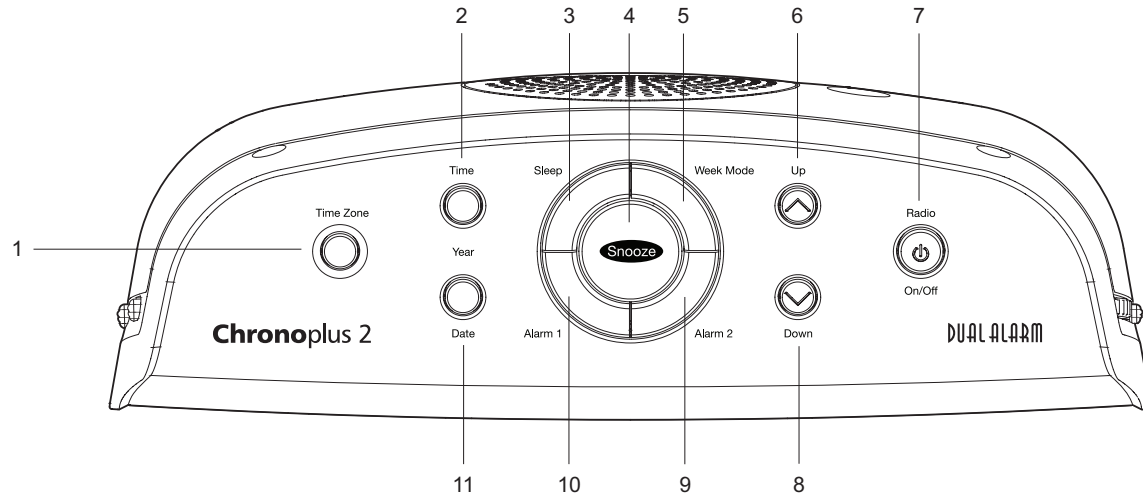

- | | | |
|---------------------|--------------------------|--------------------|
| 1. Time Zone button | 5. Week Mode button | 9. Alarm 2 button |
| 2. Time button | 6. Up button | 10. Alarm 1 button |
| 3. Sleep button | 7. Radio / On/Off button | 11. Date button |
| 4. Snooze button | 8. Down button | |

If you need any further advice, please call our Technical Helpline on :-
020 8758 0338 (Mon-Fri)

Controls

(Front)

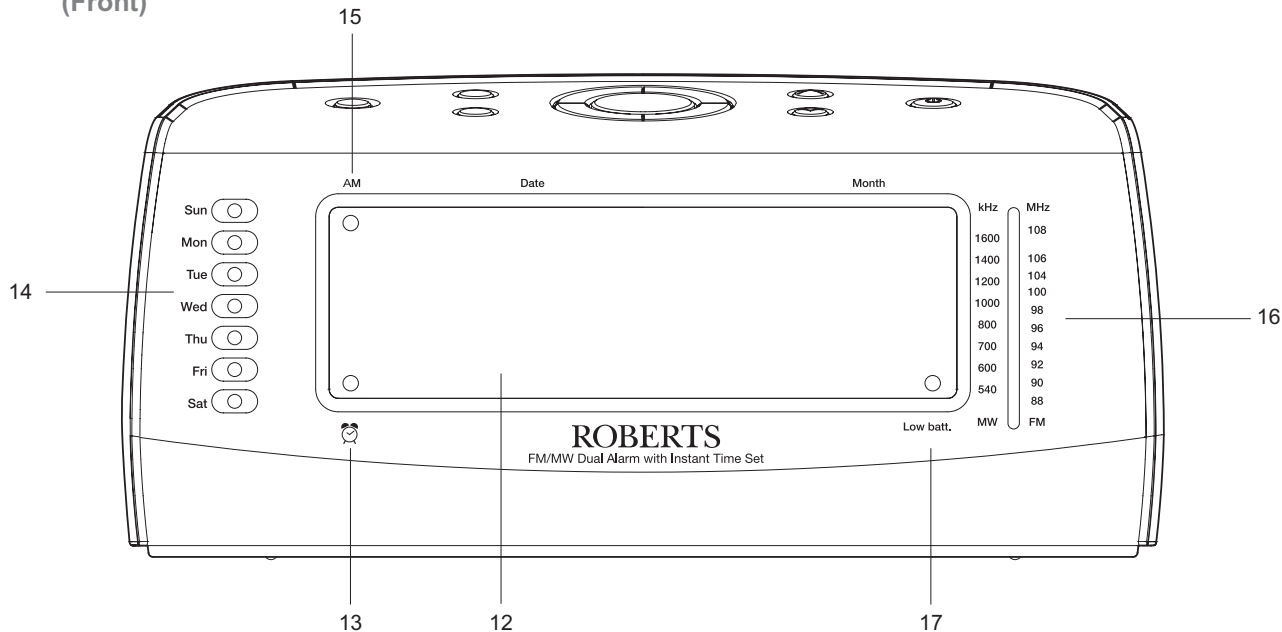

- 12. LED display
- 13. Alarm indicator
- 14. Day of week indicators
- 15. AM indicator
- 16. Dial scale
- 17. Low battery indicator

Controls

(Left and right side)

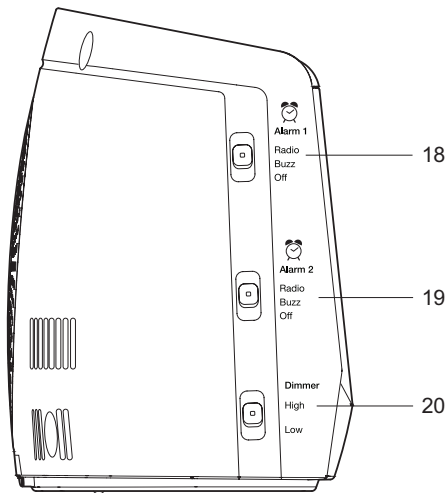

- 18. Alarm 1 switch
- 19. Alarm 2 switch
- 20. Dimmer switch

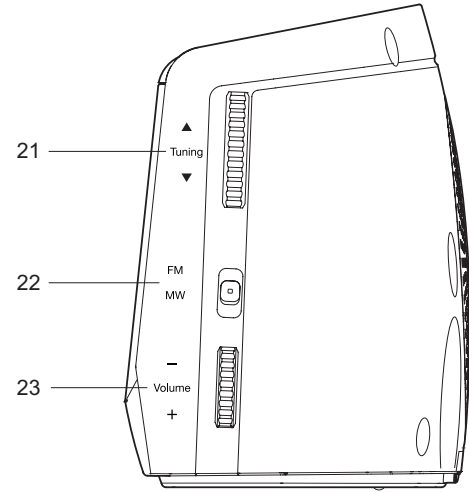

- 21. Tuning control
- 22. Waveband switch
- 23. Volume control

If you need any further advice, please call our Technical Helpline on :-
020 8758 0338 (Mon-Fri)

Controls

(Rear)

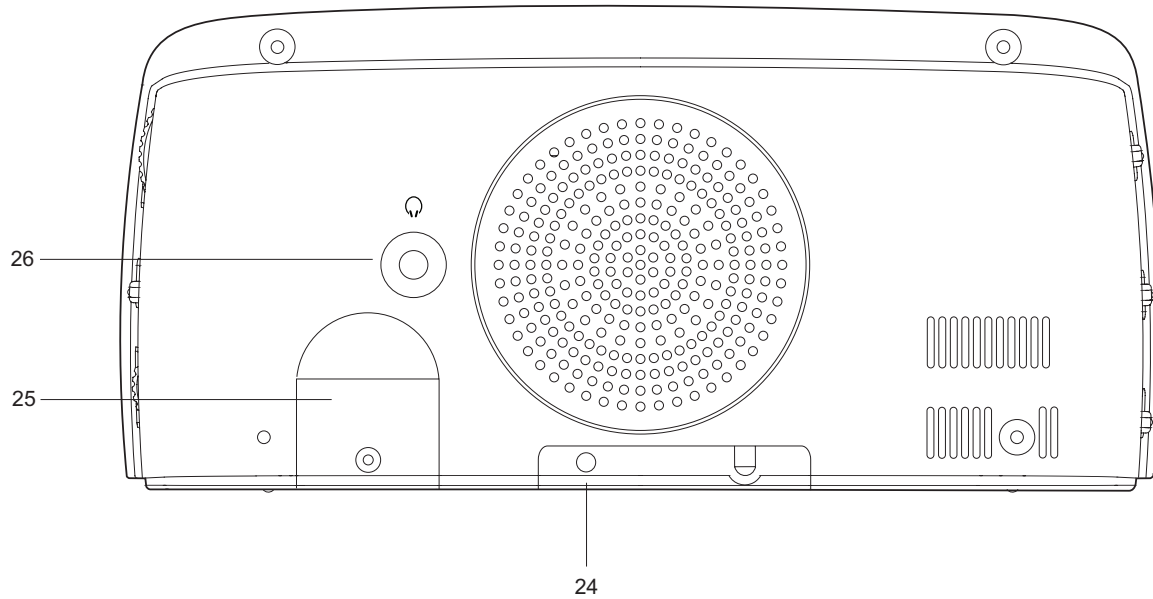

24. Wire FM aerial

25. Back-up Battery compartment

26. Headphone socket

Switching on

1. Place your clock radio on a flat surface. Plug the power cord into the wall socket and switch on.
 2. After a few seconds the time, day and date will set automatically. Your clock radio is fitted with a long life back-up battery to maintain the factory set time, day and date. Your clock radio will automatically reset to the correct time should the power source be interrupted. It will also automatically adjust for summer/winter time.
- **IMPORTANT:** The mains plug is used as the means of connecting the clock radio to the mains supply. The mains socket used for the clock radio must remain accessible during normal use. In order to disconnect the clock radio from the mains, the mains plug should be removed from the mains socket outlet completely.

See section on Back-up battery on page 15.

Should the time, date or year require adjustment follow the procedure shown in the next sections.

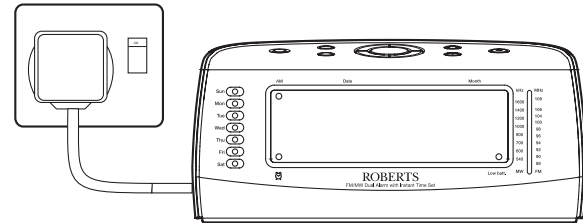

Setting the time manually

1. Press and hold down the **Time button**.
2. Whilst holding down the **Time button** press the **Up** or **Down** buttons to set the time. Release the buttons when the correct time is reached.

The clock uses a 12 hour display with a **AM indicator**. Ensure that the correct 12 hour cycle is selected.

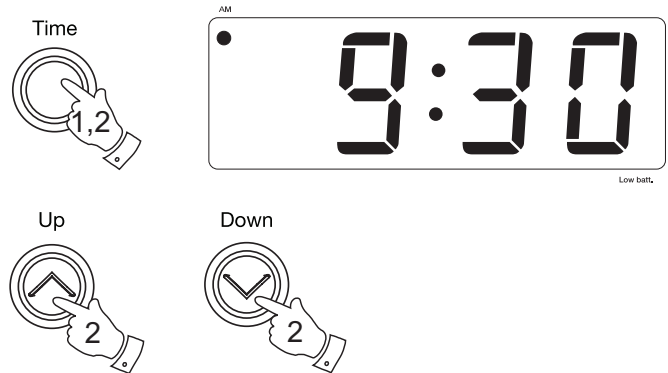

If you need any further advice, please call our Technical Helpline on :-
020 8758 0338 (Mon-Fri)

Setting the year manually

1. To set the year hold down both the **Time** and **Date buttons**. The display will change to show the year.
2. Whilst holding down the **Time** and **Date buttons** set the correct year by using the **Up** or **Down buttons**. When the **Time** and **Date buttons** are released the display will revert to showing the time.

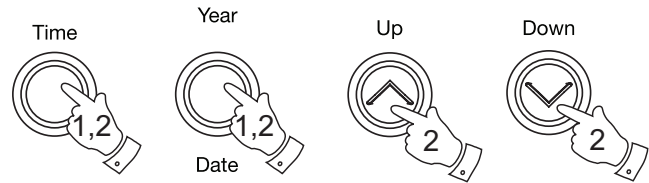

Setting the date manually

1. To set the date hold down the **Date button**.
2. Whilst holding down the **Date button** set the correct date using the **Up** or **Down buttons**.

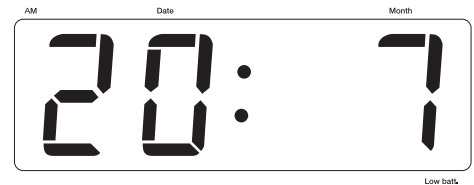

Setting alarm times

Your clock radio has two separate alarms which can be set to activate at different times. The alarms can be set to wake you by either the buzzer or the radio.

Setting alarm 1

1. Press and hold down the **Alarm 1 button**.
2. Whilst holding down the **Alarm 1 button** press the **Up** or **Down** buttons to set the alarm time. Release the buttons when the correct alarm time is reached. The clock uses a 12 hour display with a **AM indicator**. Ensure that the correct 12 hour cycle is selected.
3. Set the **Alarm 1 switch** to the Buzz or Radio position. The alarm indicator will light up. Switch to 'Off' if you wish to permanently turn off alarm 1.

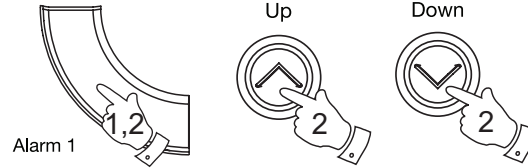

Setting alarm 2

1. Press and hold down the **Alarm 2 button**.
2. Whilst holding down the **Alarm 2 button** press the **Up** or **Down** buttons to set the alarm time. Release the buttons when the correct alarm time is reached. The clock uses a 12 hour display with a **AM indicator**. Ensure that the correct 12 hour cycle is selected.
3. Set the **Alarm 2 switch** to the Buzz or Radio position. The alarm indicator will light up. Switch to 'Off' if you wish to permanently turn off alarm 2.

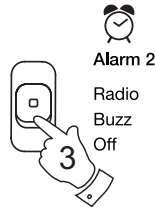
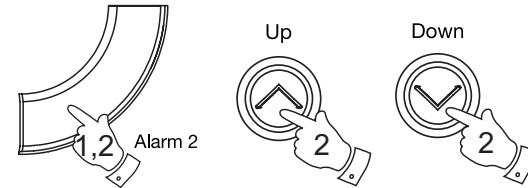

If you need any further advice, please call our Technical Helpline on :-
020 8758 0338 (Mon-Fri)

Setting alarm day

Your clock radio has three different day options for each of the alarms.

The **Alarm days** are:

Weekday - The alarm will sound on Monday to Friday

Weekend - The alarm will sound on Saturday and Sunday

Everyday - The alarm will sound everyday



Weekday alarm

1. Press and hold down the **Alarm 1** or **Alarm 2 buttons** depending on which alarm you wish to set.
2. Whilst holding down **Alarm 1** or **Alarm 2 buttons** repeatedly press and release the **Week Mode button** until Monday to Friday indicators are lit.
3. The alarm will sound Monday to Friday at the preset time for 90 minutes. To switch off the alarm until the next day press the **On/Off button**.
4. To switch off the alarms permanently set Alarm 1 or 2 switch to 'Off'.

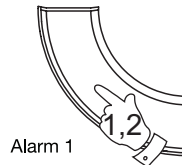

Alarm 1

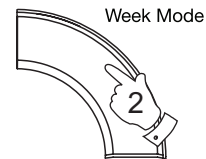

Week Mode



Radio



On/Off



Alarm 1



Radio
Buzz
Off

Weekend alarm

1. Press and hold down the **Alarm 1** or **Alarm 2 buttons** depending on which alarm you wish to set.
2. Whilst holding down **Alarm 1** or **Alarm 2 buttons** repeatedly press and release the **Week Mode button** until Saturday and Sunday indicators are lit.
3. The alarm will sound on Saturday and Sunday at the preset time for 90 minutes. To switch off the alarm until the next day press the **On/Off button**.
4. To switch off the alarms permanently set Alarm 1 or 2 switch to 'Off'.

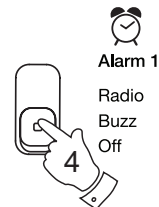
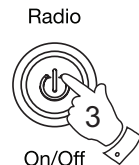
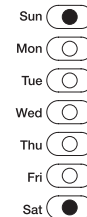
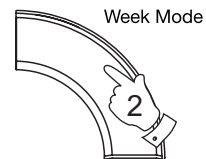
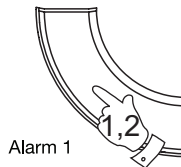

Everyday alarm

1. Press and hold down the **Alarm 1** or **Alarm 2 buttons** depending on which alarm you wish to set.
2. Whilst holding down **Alarm 1** or **Alarm 2 buttons** repeatedly press and release the **Week Mode button** until all the days of the week indicators are lit.
3. The alarm will sound everyday at the preset time for 90 minutes. To switch off the alarm until the next day press the **On/Off button**.
4. To switch off the alarms permanently set Alarm 1 or 2 switch to 'Off'.

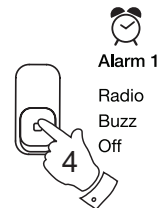
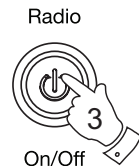
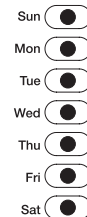
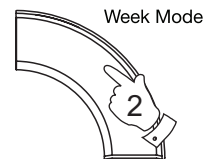
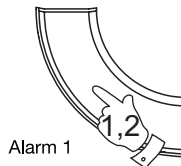

If you need any further advice, please call our Technical Helpline on :-
020 8758 0338 (Mon-Fri)

Checking alarm times

1. Press and hold down either **Alarm 1** or **Alarm 2 buttons** depending which alarm you want to check.
2. The display will change from normal time to alarm time and the **Day indicator** will light up to show the alarm day set.
3. Release the button to return to normal time.

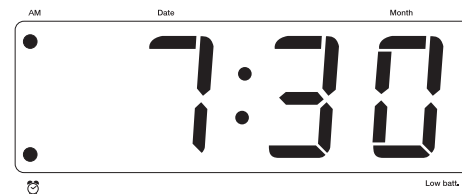
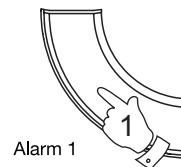
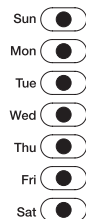

Snooze control

1. The radio or buzzer alarm can be silenced for approximately 9 minutes by pressing the **Snooze button**. This sequence can be repeated during the 90 minute alarm period.
2. During the snooze interval the **Alarm indicator** will flash.

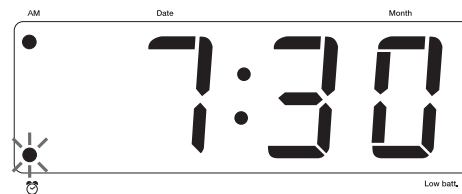

Sleep timer

Your radio can be set to turn off after a preset time has elapsed. The Sleep setting can be adjusted between 2 and 90 minutes in 1 minute increments.

1. When using the radio, press and hold down the **Sleep button**. The display will show the sleep time.
2. Whilst holding down the **Sleep button**, press the **Up** or **Down buttons** to set the sleep time between 2 and 90 minutes.
3. To cancel the sleep timer and switch off the radio before the chosen sleep time has elapsed, press the **On/Off button**.

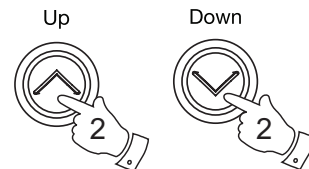
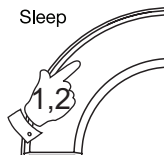

Listening to the radio

1. Switch on the radio by pressing the **On/Off button**.
2. Select the required waveband using the **Waveband switch**.
3. Tune in to the desired station using the **Tuning control**.
4. Adjust volume using the **Volume control**.
5. The **Wire aerial** located on the rear of your clock radio is for FM reception. The wire should be fully extended and positioned for optimum reception.
For MW reception there is a built in ferrite aerial. Rotate your clock radio to the position giving best reception.
6. To switch off press the **On/Off button**.

Dimmer control

In order to adapt the intensity of the display to suit the ambient room lighting, slide the dimmer switch on the left hand side of your clock radio to select the dimmer brightness between the Hi or Low setting.

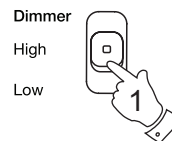
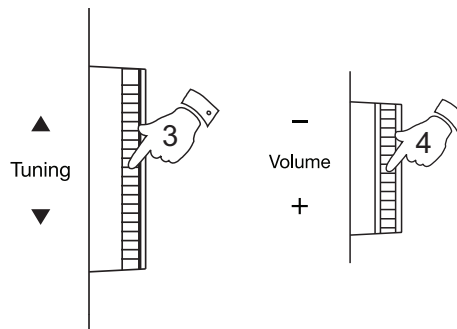
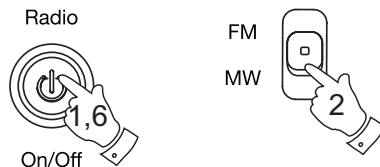

Back-up battery

As with all batteries, eventually the built in lithium battery will need to be replaced. A number of factors, such as the length of time between the date your clock radio was manufactured and the date you plugged it in for the first time, determine the amount of time before battery replacement. During this initial storage period the lithium backup battery is supplying power to your clock radio's computer memory. Once you connect your clock radio to the household AC mains supply the battery no longer supplies power to your clock radio's computer memory. A fresh backup battery can supply power to your clock radio's computer memory for 3 years even if it is never connected to a mains supply. If your clock radio was connected to the AC mains supply within a few months after it was manufactured and you experience only short interruptions to the mains supply, your battery may last for up to 5 years or even longer.

When the battery drops below a certain level the **Low battery indicator** will light. When you see this indicator you should change the battery as soon as it is convenient to do so.

See following page for details on battery replacement.

IMPORTANT: The batteries should not be exposed to excessive heat such as sunshine, fire or the like. After use, disposable batteries should if possible be taken to a suitable recycling centre. On no account should batteries be disposed of by incineration.

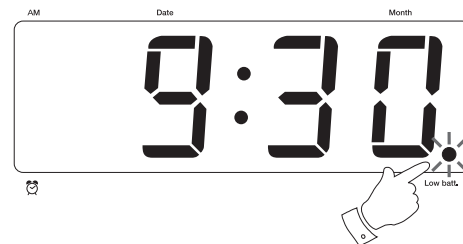

Changing the back-up battery

1. Purchase a replacement lithium backup battery type CR2032 or equivalent.
2. Remove the new battery from its packaging so that it is ready to install.
3. **Important:** Maintain connection to AC mains supply during battery replacement. This will provide power whilst the original battery is removed.
4. Open the battery cover located on the rear of the clock radio by unscrewing the screw in an anti-clockwise direction.
5. Remove the old battery from holder. Replace new battery with **+** sign facing upwards.
6. Replace the battery cover.
7. Check that the 'Battery low' indicator is not lit.

IMPORTANT: Danger of explosion if battery is incorrectly replaced. Replace only with the same or equivalent type.

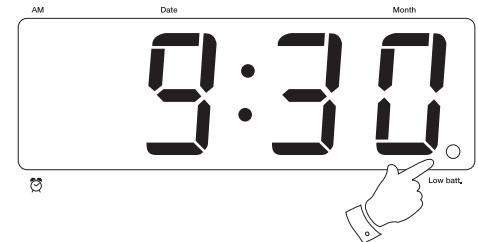
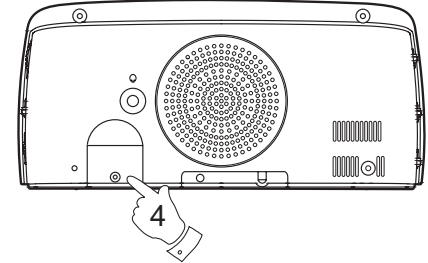
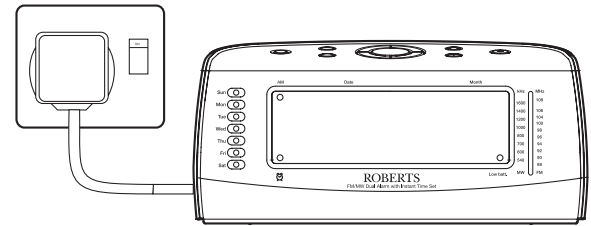

Time Zones

Your clock radio is set to UK time zone 12 GMT (UTC). Should you wish to take your clock radio to other countries the time zone will need to be reset.

1. Press and hold down the **Time Zone button** the display will show the time zone currently selected e.g. 12.
2. Whilst holding down the **Time Zone button** adjust the time zone using the **Up** or **Down buttons**. See following table for details of time zones and their offsets relative to GMT.

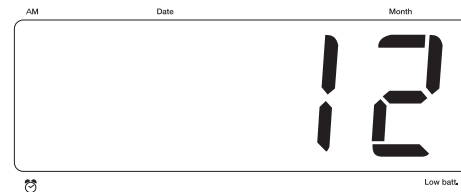
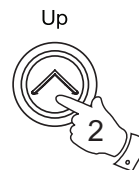

Zone	Offset (Hours)	Zone	Offset (Hours)
00	GMT +/-12	12	GMT 0
01	GMT +11	13	GMT -1
02	GMT +10	14	GMT -2
03	GMT +9	15	GMT -3
04	GMT +8	16	GMT -4
05	GMT +7	17	GMT -5
06	GMT +6	18	GMT -6
07	GMT +5	19	GMT -7
08	GMT +4	20	GMT -8
09	GMT +3	21	GMT -9
10	GMT +2	22	GMT -10
11	GMT +1	23	GMT -11

If you need any further advice, please call our Technical Helpline on :-
020 8758 0338 (Mon-Fri)

Headphone socket

A 3.5mm **Headphone Socket** located on the rear of your clock radio is provided for use with either headphones or an earpiece. Inserting a plug automatically mutes the internal loudspeaker.

IMPORTANT: Excessive sound pressure from earphones and headphones can cause hearing loss.

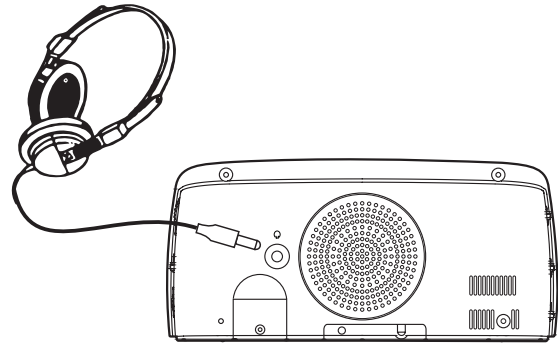

Specifications

Power Requirements

Mains	AC 230 volts, 50Hz \sim only
Back-up Battery	1 x CR2032 Lithium (3 - 5 year life)

Frequency Coverage

FM	87.5 - 108MHz
MW	515 - 1635 kHz

Circuit features

Loudspeaker	76 mm	
Output power	1W	
Aerial System	FM	Wire Aerial
	MW	Built-in Ferrite aerial

The Company reserves the right to amend the specification without notice.

Mains supply

The Chronoplus 2 will operate from a supply of AC 230volts, 50Hz  only.

For your convenience this product is supplied with a plug which is fitted with a fuse of the appropriate rating. If the plug supplied is not suitable for your socket outlet, it should be removed by unscrewing the plug top, the terminal screws, and removing the cable.

The correct style of plug to suit your household together with a correctly rated fuse should be fitted.

IF IN DOUBT - CONSULT A QUALIFIED ELECTRICIAN

IMPORTANT. DO NOT make any connection to the larger terminal which is marked with the letter E or by the safety earth symbol  or coloured Green or Green-and-yellow.

The wires in the mains lead are coloured in accordance with the following codes :-

BLUE - NEUTRAL

BROWN - LIVE

As these colours may not correspond with the coloured markings identifying the terminals in your plug, proceed as follows:-

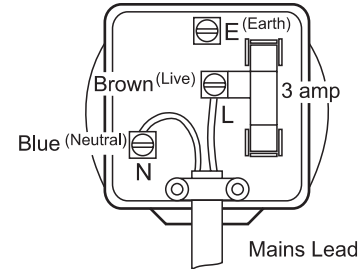

The wire coloured BLUE must be connected to the terminal marked N or coloured BLACK.

The wire coloured BROWN must be connected to the terminal marked L or coloured RED.

Fuse

This apparatus must be protected by a 3A fuse (BS1362) in a 13A plug (BS1363). If another type of plug is used a 5A fuse should be fitted in the plug, adaptor or distribution board.

IF IN DOUBT - CONSULT A QUALIFIED ELECTRICIAN.

General

Do not allow this clock radio to be exposed to water, steam or sand. Do not leave your clock radio where excessive heat could cause damage such as in a parked car where the heat from the sun can build up even though the outside temperature may not seem too high.

It is recommended that the FM band be used wherever possible as better results in terms of quality and freedom from interference will usually be obtained than on the MW band.

- The name plate is located on the underside of the unit.



- Your clock radio should not be exposed to dripping or splashing and that no objects filled with liquids, such as vases, shall be placed on the clock radio.
- It is recommended to operate the product such that there is a minimum distance (10cm recommended) to adjacent objects in order to ensure good ventilation.
- The ventilation of the product should not be restricted by covering it or its ventilation openings with items such as newspapers, tablecloths, curtains etc.
- No naked flame sources such as lighted candles should be placed on the product.
- It is recommended to avoid using or storing the product at extremes of temperature. Avoid leaving the unit in cars, on window sills, in direct sunlight etc.

Troubleshooting

In case of malfunction due to electrostatic discharge, it may be necessary to reset the product to resume normal operation. This may generally be performed by turning the unit off and on. In some cases a more complete reset may be needed, by removing all sources of power (battery and mains) when turned off.

Guarantee

This instrument is guaranteed for twelve months from the date of delivery to the original owner against failure due to faulty workmanship or component breakdown, subject to the procedure stated below. Should any component or part fail during this guarantee period it will be repaired or replaced free of charge.

The guarantee does not cover:

1. Damage resulting from incorrect use.
2. Consequential damage.
3. Receivers with removed or defaced serial numbers.

Procedure:

Any claim under this guarantee should be made through the dealer from whom the instrument was purchased. It is likely that your Roberts' dealer will be able to attend to any defect quickly and efficiently but should it be necessary the dealer will return the instrument to the Company's service department for attention. In the event that it is not possible to return the instrument to the Roberts' dealer from whom it was purchased, please contact Roberts Radio Technical Services at the address shown on the rear of this manual.

These statements do not affect the statutory rights of a consumer.

ROBERTS RADIO TECHNICAL SERVICES

97-99 Worton Road
Isleworth Middlesex
TW7 6EG

Technical Helpline:- 020 8758 0338 *(Mon-Fri during office hours)*

Website: <http://www.robertsradio.co.uk>

© 2009 Roberts Radio Limited



Issue 1

